



LCD display



Paper Cartridge



Direct PLU keys  
& function keys

# CL5500-D SERIES

**It's the best network solution for your business!**

- Flexible & reliable network system (wired/wireless)
- Easy loading paper cartridge
- Free format label designs
- User-friendly PC software



**CAS**

# CL5500-D SERIES



## Hardware

### Ergonomic Mechanical Design

With its ergonomic design, the CL5500-D provides smooth operation while remaining non-strenuous on the operator.

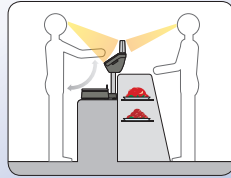

### PLU Keys

The embossing membrane type keypad adds a sophisticated look of CL5500-D. Double-click function provides easy access to the key's secondary PLU, totaling in 148 PLU. Shorten operation time by customizing keys.

### Display

A unique combination of display types suitable for any environment. Numeric LCD (4/5/6/6) + Graphic LCD (32 X 202)

### Printer

High speed thermal printer that supports label/ticket printing. Guaranteed satisfaction with 100mm/sec speed and 202dpi resolution.



### Customized Keys

CL5500-D provides an additional 4 customized keys. While using these keys, the operator can access frequently used functions easily.



### Platform

Parts can be replaced without breaking seals. So re-verification is not necessary after repair.

### Paper Cartridge

Cartridge loading type, quick and easy replacement of new label/ticket roll.



### Interface

It supports various interface, such as RS-232, PS2, RJ11, USB, Ethernet, etc.



RS-232



PS2



RJ11



USB



Ethernet



# Network Scale

## Software

### Label Formats

There are 40 preset labels are installed in the scale and 20 of the label formats can be modified freely with CL-Works PC Program.

Various Label sizes can be used:

- Continuous Label/ticket
- Up to 200mm label length

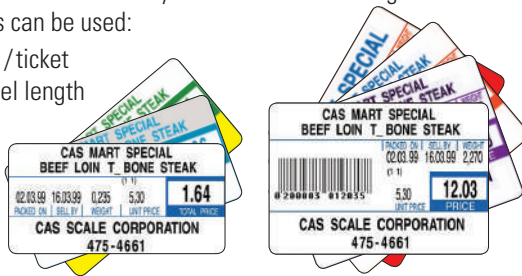

### Barcode

Almost every conventional barcode types are available:

- UPC, EAN13, EAN13A5, I2OF5, CODE128, CODE39, CODE93, CODABAR, IATA2OF5, GS1 Databar, etc.



### PC Software: CL-Work

User-Friendly Scale management software. PLU programming, store data, sales report, label editor, key-pad editor and much more. Control all the program data by CL-Works program. Other types of CL5000 share this software with CL5500-D.

### Short-cut Menu System

No need to scroll through menus for programming settings. Unique 4 digit 'Menu Code' entry pin helps pinpoint the desire program field.

ex) Menu code "1120" is for editing PLU name.

### CL-work

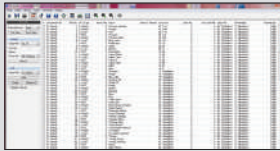

**PLU Editor** | Enables easy PLU control. Allows PLU's management by excel.

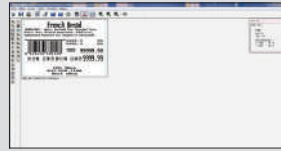

**Label Editor** | 20 modifiable label formats. Easy downloading of label formats.

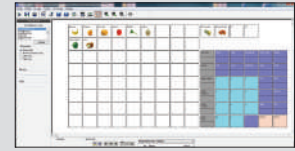

**Keypad Editor** | Easy to setup and download. Key design color Image. Keypad supported.

## Network System

- TCP/IP communication protocol
- IEEE802.11G specification wireless network
- 64/128 bit WEP data security system, WPA(TKIP), WPA-II
- One to one, multi to multi & wired/wireless network
- Network structure for
  - Large, medium and small independent markets
  - Pre-pack and self-service counter
  - Hyper market

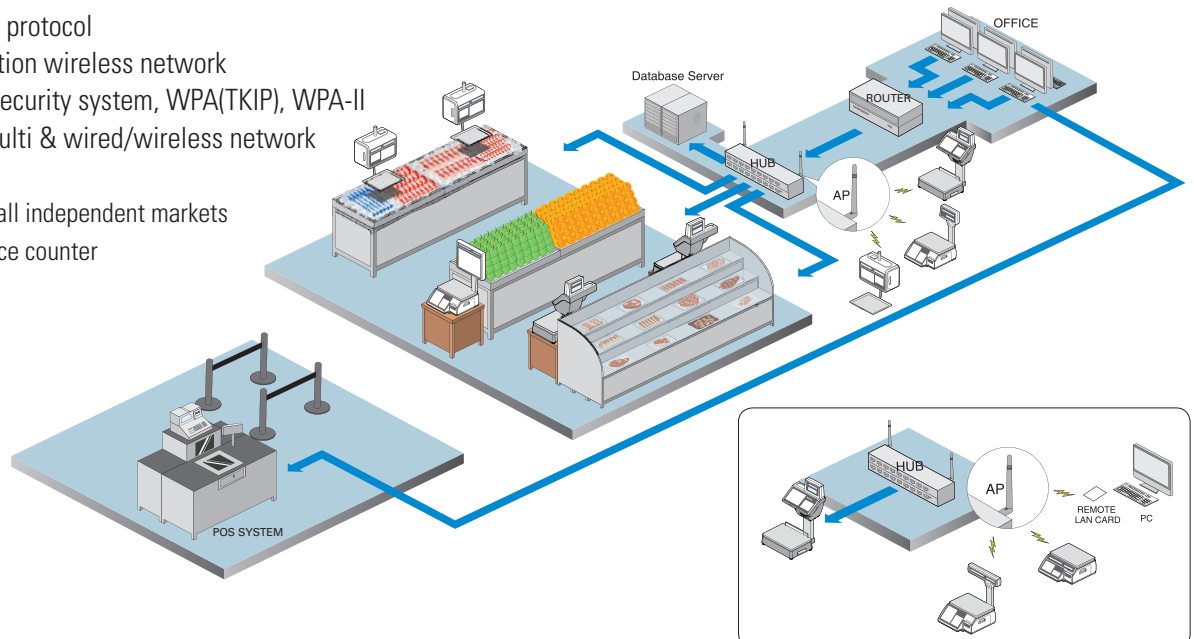

▲ Mixed with Wired / Wireless Network

▲ Multi to Multi

# CL5500-D SERIES | Network Scale

## SPECIFICATIONS

Model	CL5500-D		
Max.capacity (kg)	3 / 6	6 / 15	15 / 30
Readability (g)	1 / 2	2 / 5	5 / 10
External resolution	1 / 3,000 (Dual interval)		
Display type	Graphic LCD(32 x 202) + Numeric LCD(4/5/6/6)		
Printing speed	100mm/sec		
Printer resolution	202dpi		
Label size (mm)	Width: 40 ~ 60 Length: 30 ~ 200		
Power	AC 100 ~ 240V, 50 / 60Hz		
Operating temperature	-10°C~+40°C		
Platter size (mm)	380(W) x 270(D)		
Dimensions (mm)	396(W) x 464(D) x 612(H)		
Product weight (kg)	12.64		

## DIMENSIONS

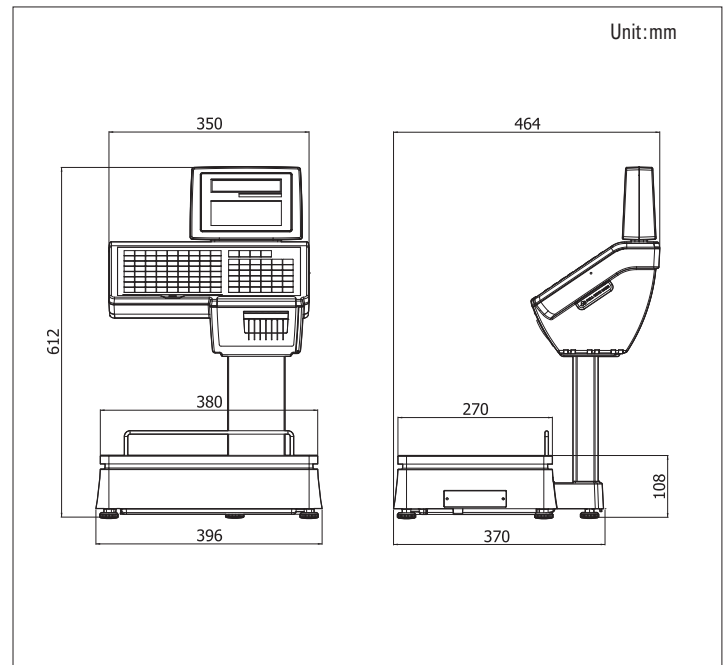

## FEATURES

- Memory capacity: 8,000 plus & 1,000 ingredients
- Speed key: 144 PLU keys (72 keys x 2 via double-clicking)
- Supporting free label format design
- High-speed thermal printer (100mm/s)
- "Cartridge loading type" label installation
- 40 fixed format & 20 customized format design

## OPTIONS

- Wireless bridge card
- Platter with back rail
- PC manager program (CL-Works; also compatible with CL5000 & CL5000J)
- PLU Plastic cover

## PRODUCT LINE UP (It can be fully integrated with CL5000 & CL5000J series)



# CAS

CAS BLDG., # 440-1, SUNGNAE-DONG,  
GANGDONG-GU, SEOUL, KOREA  
TEL\_ 82 2 2225 3500  
FAX\_ 82 2 475 4668

<http://www.globalcas.com>

Specifications are subject to change for improvement without prior notice.